

Notes

- Dimensions to centre of lamp
- SR & SL booms symmetrical lamp spacing
- Boom arms used for torms and pros should point 90* perpinducular to pole
- Boom arms for Mid booms should point into stage
- Ladder spacing set to 1000mm
- Full ladder 3000mm length
- Part ladder 2000mm length

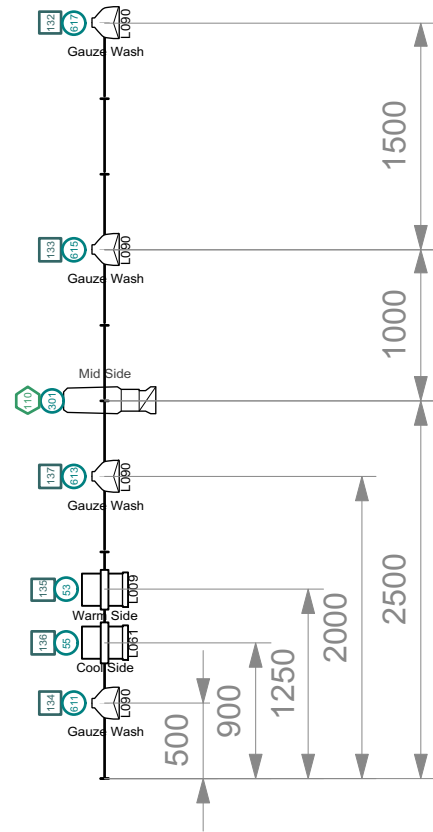

SR Pros

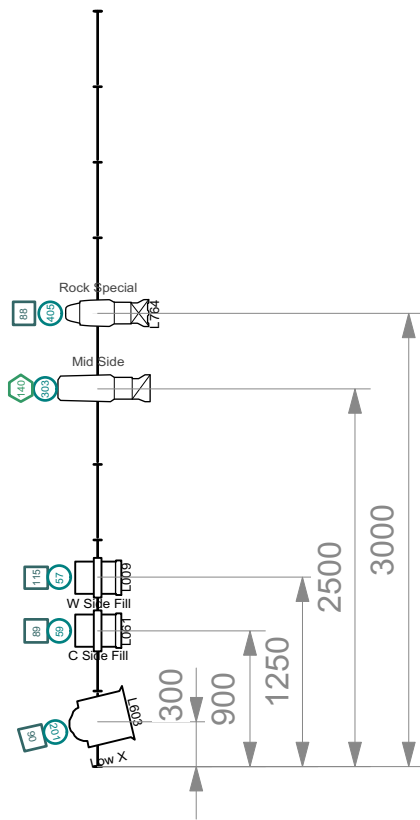

SR Torm

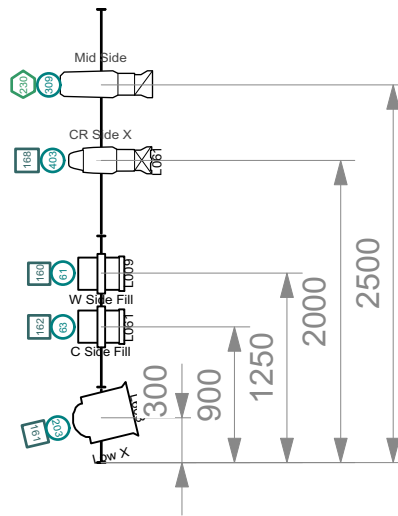

SR Mid Boom

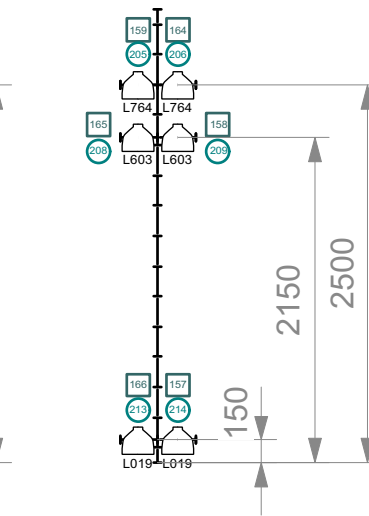

SR US Boom

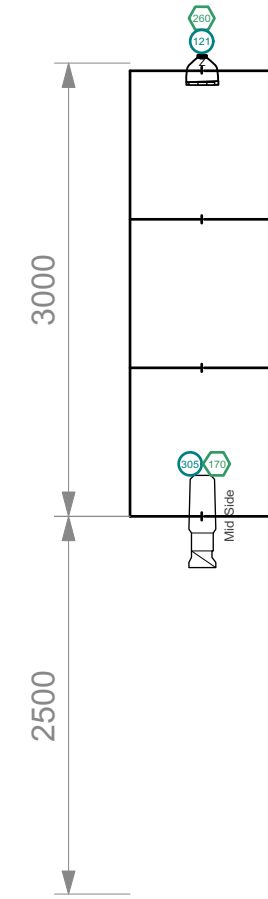

DSR Ladder

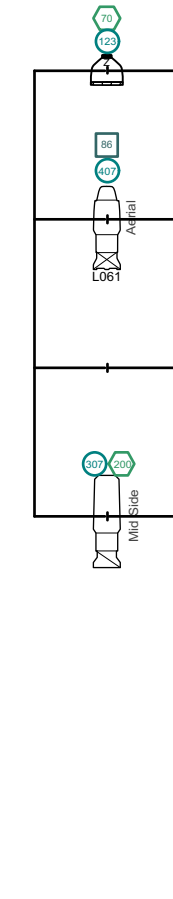

CSR Ladder

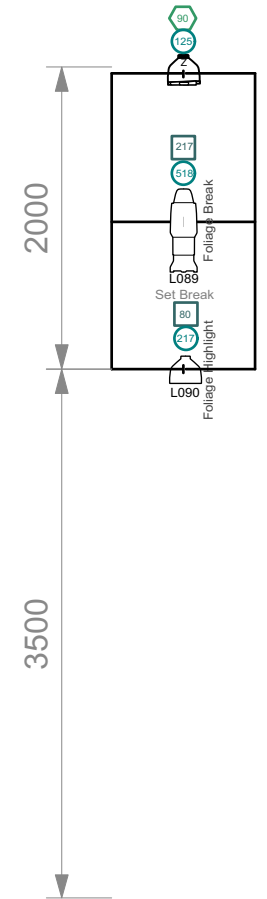

USR Ladder

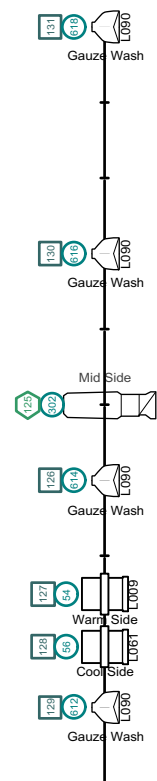

SL Pros

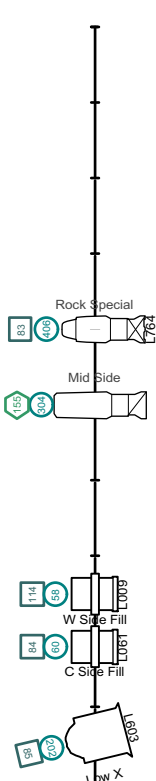

SL Torm

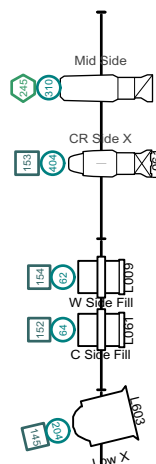

SL Mid Boom

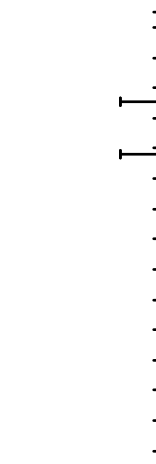

SL US Bom

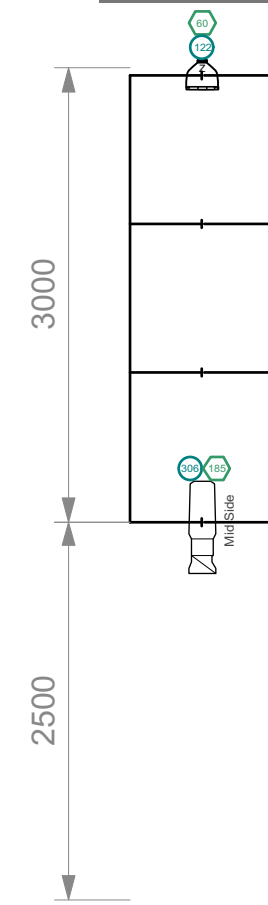

DSL Ladder

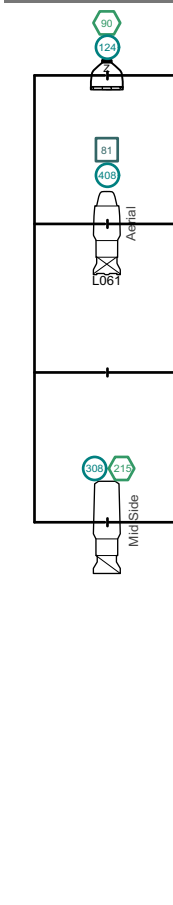

CSL Ladder

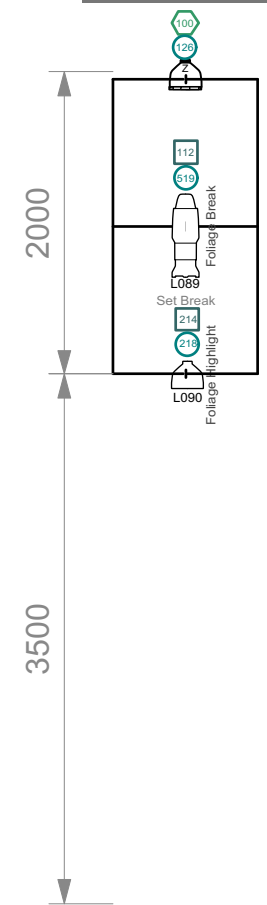

USR Ladder



The Jungle Book

LX Boom/Ladder Plan V5

Director	Hugh Hodgart
Stage Manager	Laurie Sutton
TSM	Yesha Subotincic West
Drawn By	S Keenan

Designer	Robin Peoples
LX Design	Stephen Keenan
Date	06/12/17
Scale	N/A

Drawing Number	3
----------------	---